

# JT-DPM8600

Programmable laboratory power supply unit



## 1. SAFETY NOTE

**Our product is suitable for up to 75 volts DC. Working with voltages above 60 V DC is reserved for trained electricians due to the risk of electric shock, which can lead to serious injury or death. Non-electricians must use a voltage source below 60 volts DC.**



## 2. GENERAL INFORMATION

Dear customer,

we would like to thank you for choosing our product. Below you will find important information on commissioning and use. Should any unexpected problems arise during use, please do not hesitate to contact us.

The DPM 8600 series comprises programmable power supply units that are characterized by high performance, compact design and optimal construction. They also feature TTL or RS485 communication protocols and also support the Modbus RTU communication protocol. This enables the development of custom protocols and provides a versatile solution for design and test requirements.

A special feature of the DPM8600s is the ability to control them with a wireless remote control. This remote control has a 2.4-inch LCD screen, displays many parameters, is easy to operate, contains a rechargeable lithium battery and offers a range of up to 10 meters. Uniquely, multiple power supplies can be controlled simultaneously.

The power supply unit is suitable for a wide range of applications, for example as an ammeter, smart meter, LED driver, voltage regulator for solar systems or in industrial control systems.

If the device is damaged or the scope of delivery is incomplete, please contact our support team immediately and do not use the device. Using the device if it is damaged can lead to short circuits or ignition of the device.

### 3. TECHNICAL SPECIFICATIONS

Modell	DPM-8605	DPM8624-485
Input voltage	10 - 75 V	10 - 75 V
Output voltage	0 - 60 V	0 - 60 V
Output current	0 - 5 A	0 - 24 A
Output power	0 - 300 W	0 - 1440 W
Communication interface	DPM-8605 DPM8624-485	TTLserial communication interface. RS-485 communication interface.
Voltage resolution	10 mV	
Current resolution	1 mA	10 mA
Output shaft	< 50 mVpp	
Efficiency	92 %	
Display resolution	10 mV, 1 mA	10 mV, 1 mA
Output tolerance	Voltage: $\pm 2 \%$ / Current: $\pm 5 \%$	
Response time	< 50 ms	
Dimensions	120 - 131 - 55 mm	150 - 120 - 59 mm
Applied Ambient temperature	-25 - 60 °C	

**ATTENTION:** In the following description, DPM8624 is used as an example . The DPM8605 works in a similar way to the DPM8624.

## 4. MODULE

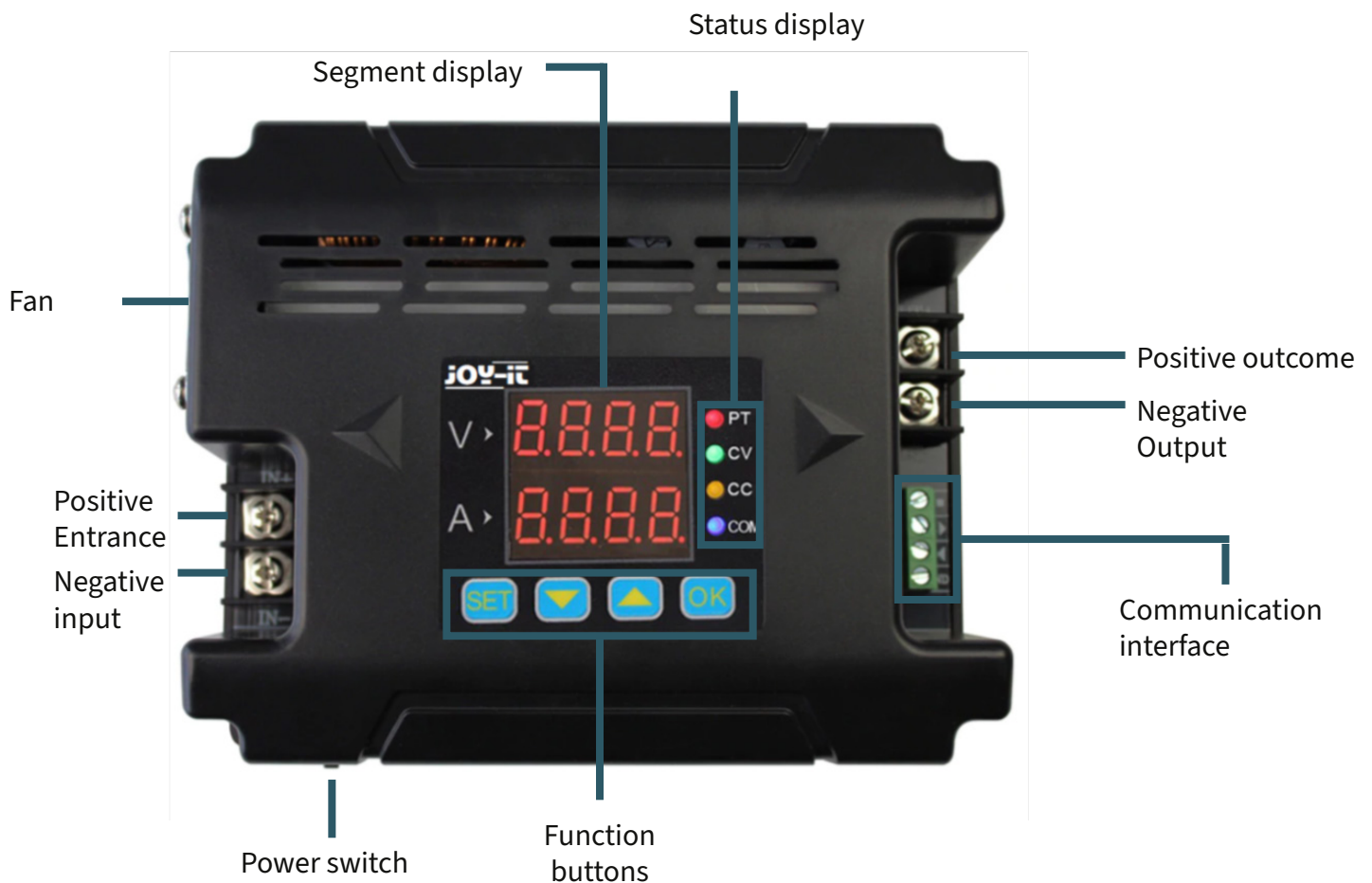

## 5. DISPLAY

<b>0500</b> shows voltage values	<b>4-Fd</b> Activates fast response
<b>0300</b> shows current values	<b>--1-</b>
<b>1-SA_10-</b> Sets upper limit for voltage and current	<b>5-CS</b> Simple communication
<b>1-SA</b> Sets lower limit for voltage and current	<b>--0-</b>
<b>-11-</b>	<b>5-CS</b> Communication with Modbus
<b>1-SA</b> Deletes upper and lower limit of voltage	<b>--1-</b>
<b>-12-</b> and current	<b>6-bd</b> Possible to select 2.4, 4.8, 9.6, 19.2, 38.4,
<b>2-dF</b> no factory settings	<b>0096</b> 57.6, 115.2 (Kbps) as Baud
<b>--n-</b>	<b>7-Ad</b> 99 Communication addresses
<b>2-dF</b> Resets the device to factory settings	<b>-01-</b>
<b>--y-</b>	<b>8-CH</b> 31 communication channels from 00 to 30
<b>3-0n</b> When the device starts up, the	<b>-01-</b> (00 means none connected)
<b>--0-</b> Output can be activated manually	<b>-Ld-</b> Retrieves values from memory location
<b>3-0n</b> Output starts automatically when the	<b>--0-</b> 0 - 9
<b>--1-</b> device is started	<b>-SA-</b> Saves values to memory location(0 - 9)
<b>4-Fd</b> Disables fast response	<b>--0-</b>
<b>--0-</b>	<b>Corr</b> Calibrates voltage and current
	<b>-°C-</b> Displays the temperature of the device
	<b>0280</b>

## 6. STATUS DISPLAY



PT	<u>overheating protection indicator</u> If the temperature exceeds 80°C, this indicator lights up because the overheating protection is activated.
CV	<u>Constant voltage display</u> The CV display lights up when a constant voltage is output.
CC	<u>Constant current display</u> The CC indicator lights up when a constant current is being output.
COM	<u>Communication display</u> The COM LED lights up when communication is taking place.

## 7. SETUP

First of all, you must connect the input and output correctly to ensure that the input voltage is high enough so that the Device can be put into operation.

**ATTENTION:** The input voltage must be 0.5 V higher than the output voltage.

You can now change the voltage and current values to suit your needs. The "V" on the segment display shows the voltage values in volts and "A" shows the current values in amperes. The LCD display shows the voltage values with 2 decimal places (00.00) and the current values with 3 decimal places (0.000). If you now press "OK", you activate the device. The CV and CC LEDs then light up to indicate that the output is active.



The standard setting is 5 V and 3 A.







Press "SET" so that a value starts to light up blue.



Press again to select the next value .





The value can be set using the  but-  tons and be changed.



Press "OK" to switch the output on and off. If the load current is below the set maximum current, the output switches to constant voltage mode and CV lights up.



When the load current reaches the set maximum current, the output current is equal to the set current and the device switches to the constant current, which causes the CC LED to light up.

Press  or  to go to the save and load menu, as well as to the temperature display and the calibration menu.

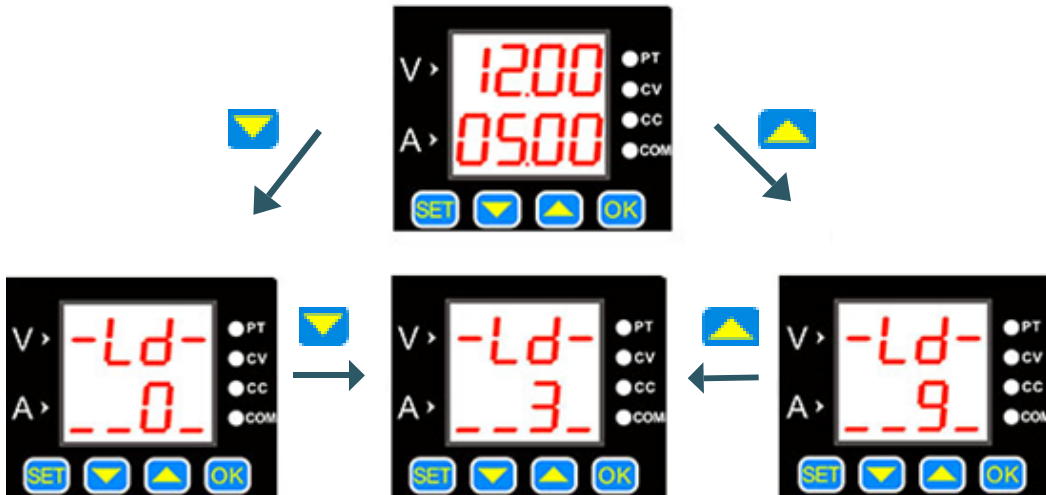

If you press **SET**, you can load the saved values. You can select the data records with **▼** and **▲**. Press **OK** to confirm.



Press **▼** to return to the menu. To calibrate the device, press **OK**. The calibration functions are explained in more detail below.

Press **▼** to exit the temperature display.

## **Calibration**



1. If the set voltage is higher than 20 V, the output is activated and no load is connected, the output current can be calibrated to zero using the "Corr." function. For example, if you set the output voltage to 25 V, the current is zero-calibrated at this voltage.
2. If the output is deactivated and calibration is activated, the zero points are set for both the voltage and the current.
3. A short circuit on the activated output with a maximum output current above 2 A results in the calibrated value corresponding to the previously set value. So if you set the output current to 3 A, the output is calibrated to 3 A accordingly.

## Temperature display

The temperature display reflects the appliance temperature, which is regulated by the fan speed and the overheating protection. If the temperature exceeds 40 °C, the fan starts working and increases its speed by one degree for every additional 5 °C. At 60 °C, the fan reaches its maximum speed. A temperature of 80 °C activates the overheating protection, which switches the appliance off automatically.

## SET menu

Press and hold **SET** to open the SET menu. You can switch between the menu items by pressing **SET**.

You can set the values in the menu using  and . You must press **OK** to confirm the settings.



This menu item declares the voltage and current limits. The "10" here means the upper limit, the "11" the lower limit and the "12" the deletion of the limits.



This menu item allows you to reset the device to the factory settings. Selecting "Y" performs a reset, while "N" retains the current settings.



This menu item serves as a status interface. It allows you to set whether the output is activated automatically ("1" option) or must be activated manually ("0" option) when the device is started up.





The menu item declares the response time of the device when discharging. Here, "0" means a slow response time and "1" a fast one.



The menu item contains the communication protocol. Here, "0" means the simple communication protocol and "1" means the Modbus communication protocol.



Here you can change the baud rates. There are 7 different rates available in Kbps.



You can enter the local addresses in this menu item. There are 99 communication addresses available.

### **Upper and lower limit of voltage and current**

These limits can be adjusted in the SET menu. For example, if you set 50 V and 5 A on the main screen and then activate the upper limit, you cannot increase the values beyond 50 V and 5 A. The lower limit works in the same way, so values cannot be set below these limits. If both limits are active, changes are only possible within this defined range.



## **Communication protocol**

The device supports two communication protocols: a simple protocol and the Modbus protocol, both selectable in the SET menu. The simple protocol is an in-house development that is characterized by its user-friendliness. The Modbus protocol corresponds to the industry standard.

## **Fast response**

After activating the quick response function, the response time of the device is shortened when the voltage is reduced. For example, if the output voltage is reduced from 30 V to 5 V, this process takes 5 seconds without the quick response function. However, if this function is activated, the device reduces the voltage within just 1 second.

## **Activation of the standard status**

This setting determines whether the output is automatically activated or deactivated after the device starts up. If the function is activated, the output is activated immediately after start-up. If the function is deactivated, the output must be switched on manually.

## **Key lock**

The button lock is activated by pressing and holding the "OK" button. Another long press releases the lock again.

## **8. SOFTWARE**

We also provide you with software that you can download from our website: [www.joy-it.net](http://www.joy-it.net)

After completing the installation, connect the laboratory power supply unit to your PC via a TTL or RS485 adapter. Please note that an incorrect connection can impair communication between the computer and the laboratory power supply unit.

DPM	TTL	RS485
V ■	not connected	not connected
A ►	RX (weiß)	A
B ◀	TX (green)	B
GND	GND (black)	not connected

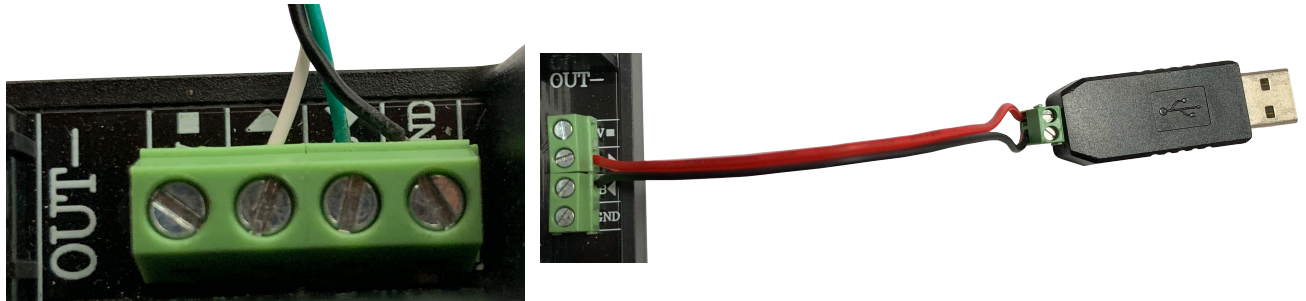

Once the cables have been connected to the power supply unit in accordance with the instructions in the image and table, connect the device to the PC via USB. In the Device Manager under "Ports (COM & LPT)", check which port the power supply unit is connected to; in this example it would be COM4.

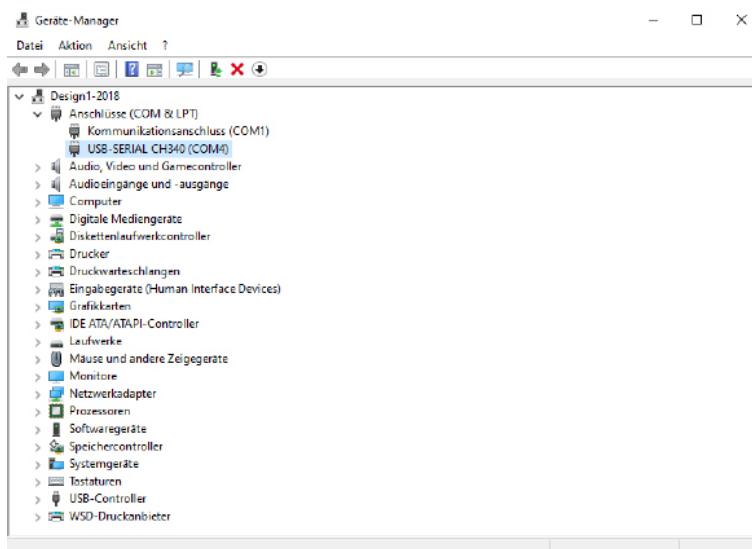

You must now install drivers to enable communication between the power supply unit and the PC. To do this, you can use the NI-VISA software, which you can download [here](#) which you can download here.

It is recommended to deactivate the Windows quick start during installation to avoid possible problems with hardware detection at . Only select "NI PXI Platform Services - Runtime" for installation, as this module is the only one required for the DPM software. After installation, the PC will restart automatically. You can then open the program.

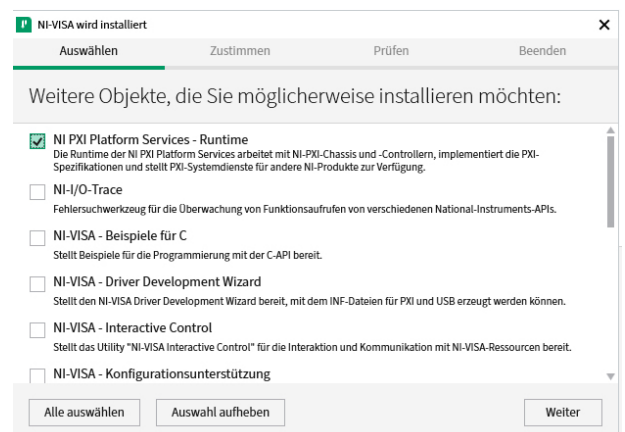

**Attention!** You must open the "DPM8608en" program for the DPM8605, but the "DPM8624en" program for the DPM8624.

In the program, select the port of the power supply unit and click on "Connect" to connect the PC to the power supply unit.

The baud rate is set to 9600 by default and can be set to the value set in the device if necessary.

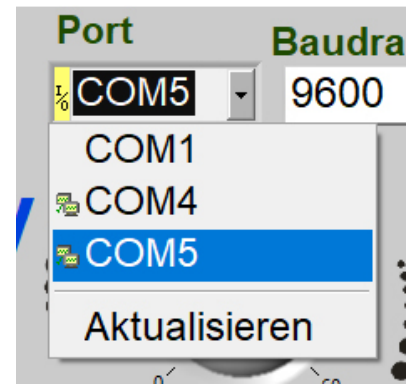

The device is connected when the "Connect" button lights up green. Further operation is as follows:

Communication address

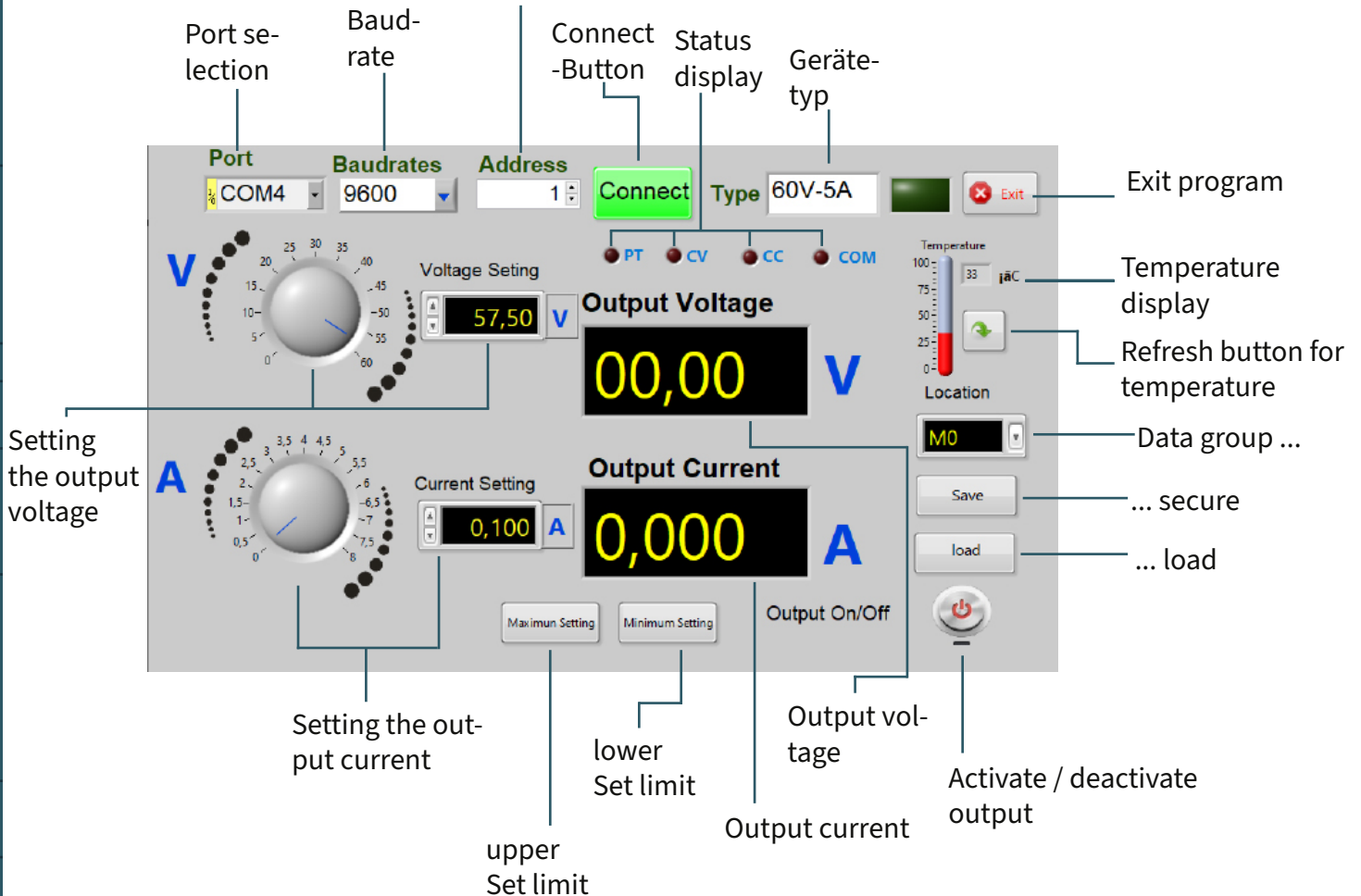

The output is deactivated when the button is displayed in red. It turns green as soon as it is activated.



## 9. DECLARATION OF CONFORMITY

Hereby, Simac Electronics Handel GmbH declares that the radio equipment types JT-DPM8605 and JT-DPM8624 are in compliance with Directive 2014/53/EU. The full text of the EU Declarations of Conformity is available at the following internet addresses:

[www.simac-gmbh.de/CE/jt-dpm8605.pdf](http://www.simac-gmbh.de/CE/jt-dpm8605.pdf)  
[www.simac-gmbh.de/CE/jt-dpm8624.pdf](http://www.simac-gmbh.de/CE/jt-dpm8624.pdf)

### Information on the transmission power and frequency band of the DPM8605:

Frequency band: 2412~2472 MHz  
Max. Transmit power: 11.93 dBm

### Information on the transmission power and frequency band of the DPM8624:

Frequency band: 2412~2472 MHz  
Max. Transmit power: 11.93 dBm

## 10. OTHER INFORMATION

Our information and take-back obligations under the German Electrical and Electronic Equipment Act (ElektroG)



### **SYMBOL ON ELECTRICAL AND ELECTRONIC EQUIPMENT:**

This crossed-out garbage can means that electrical and electronic appliances do not belong in household waste. You must hand in the old appliances at a collection point. Before handing them in, you must separate used batteries and accumulators that are not enclosed by the old appliance.

### **RETURN OPTIONS:**

As an end user, you can hand in your old appliance (which essentially fulfills the same function as the new appliance purchased from us) for disposal free of charge when purchasing a new appliance. Small appliances with no external dimensions greater than 25 cm can be disposed of in normal household quantities regardless of whether you have purchased a new appliance.

### **POSSIBILITY OF RETURN AT OUR COMPANY LOCATION DURING OPENING HOURS:**

SIMAC Electronics GmbH, Pascalstr. 8, D-47506 Neukirchen-Vluyn

### **RETURN OPTION IN YOUR AREA:**

We will send you a parcel stamp with which you can return the device to us free of charge. To do so, please contact us by e-mail at [Service@joy-it.net](mailto:Service@joy-it.net) or by telephone.

### **PACKAGING INFORMATION:**

Please pack your old appliance securely for transportation. If you do not have suitable packaging material or do not wish to use your own, please contact us and we will send you suitable packaging.



## 11. SUPPORT

We are also there for you after your purchase. If any questions remain unanswered or problems arise, we are also available to assist you by e-mail, telephone and ticket support system.

E-Mail: [service@joy-it.net](mailto:service@joy-it.net)

Ticket-System: <http://support.joy-it.net>

Phone: +49 (0)2845 9360 - 50 (Mon. - Thur.: 09:00 - 17:00 ó clock, Fri.: 09:00 - 14:30 ó clock)

For further information, please visit our website:

[www.joy-it.net](http://www.joy-it.net)